

**MODEL AR-210**  
**TERMINAL NODE CONTROLLER**



**OPERATING INSTRUCTIONS**

**AOR, Ltd.**

Radio Communication Products & Systems

AOR AR210 TNC ADDENDUM TO THE OPERATING MANUAL

**RS232 Connections for IBM**

Please replace the two tables shown on page 1-2 with the following information.

Table 1-2 IBM PS2, AT 9 pin connector

AR210	9 WAY IBM COMPUTER RS232
2	2
3	3
5	5
7	7
8	8

Table 1-3 IBM PC/XT 25 pin connector

AR210	25 WAY IBM COMPUTER RS232
2	3
3	2
5	7
7	4
8	5

## FCC NOTICE

This equipment generates, uses, and can radiate radio frequency energy and if not installed and used in accordance with the instruction manual, had cause interference to radio communications. This equipment has been tested and found to well exceed the limit for a Class A computing device pursuant to Subpart J of Part 15 of FCC Rules, which are designed to provide reasonable protection against such interference when operated in a commercial environment. If this equipment does cause interference to radio or television reception, which you can determine by turning the equipment off and on, try to correct the interference by one or more of the following measures:

- Move the computing device away from the receiver being interfered with.
- Relocate the computing device with respect to the receiver.
- Re-orient the receiving antenna.
- Plug the computing device into a different AC outlet so that the computing device and receiver are on different branch circuits.
- Disconnect and remove any I/O cables that are not being used.  
(Unterminated I/O cables are a potential source of high RF emission levels. )

If you need additional help, consult your dealer or ask for assistance from the manufacturer. You may also find the following booklet helpful : " How to Identify and Resolve Radio-TV Interference Problems. " This booklet is available from the U.S. Government Printing Office, Washington, D.C. 20402, Stock No. 004-000-00345-4.

AR-210 Operating Instructions  
Copyright (c) 1992, AOR, Ltd. Tokyo Japan  
by Toshi T. Totsuka  
All Rights Reserved.

### Credits

*Portions of this manual was copied from the model HK-21 TNC operating manual under the acceptance and courtesy of the Heath Company, Benton Harbor, MI., U.S.A.*

*Portions of this manual was copied from the TAPR TNC-2 operating manual under the acceptance and courtesy of the Tucson Amateur Packet Radio Corporation.*

### Trademarks

*IBM, PC, XT, AT, and PS/2 are registered trade marks of International Business Machines Corporation.  
PC DOS is a registered trademark of International Business Machines Corporation.  
Apple and Apple Macintosh are registered trade marks of Apple Computer, Inc.  
CompuServe is a registered trademark of CompuServe, Inc.  
GEline is a trademark of General Electric Corporation.  
Hayes is a registered trademark of Hayes Microcomputer Products, Inc.  
Procomm and Procomm Plus are registered trade marks of Datastorm Technologies, Inc.  
Microsoft, MS, and MS-DOS are registered trademarks, and Windows is a trade mark of Microsoft Corporation.  
VT-100 is a trade mark of Digital Equipment Corporation.*

# TABLE OF CONTENTS

INTRODUCTION	.....	III
SPECIFICATIONS	.....	IV
1. INSTALLATION	.....	1-1
Computer Connections	.....	1-1
Software Requirements	.....	1-4
Radio Connections	.....	1-6
Power Source	.....	1-8
Nicad Battery	.....	1-9
2. OPERATIONAL TESTS AND ADJUSTMENT	.....	2-1
Preliminary Tests	.....	2-1
Adjustments	.....	2-3
Audio Level Adjustment	.....	2-3
PTT Line Adjustment	.....	2-3
3. OPERATION	.....	3-1
General	.....	3-1
Terminal Characteristics	.....	3-3
Getting Started	.....	3-3
Operating Modes	.....	3-7
Flow Control	.....	3-9
Display Options	.....	3-11
Editing Commands	.....	3-13
Special Operating Configurations	.....	3-13
Packet Timing Functions	.....	3-17
Monitor Functions	.....	3-19
Using the Bulletin Board Feature	.....	3-21
4. COMMAND AND MESSAGES	.....	4-1
Command List & Command Syntax	.....	4-1
5. IN CASE OF DIFFICULTY	.....	5-1
APPENDIX - List of Commands and Defaults	.....	A-1
SERVICE INFORMATION	.....	Inside rear cover

## INTRODUCTION

The AOR Model AR-210 Terminal Node Controller is designed as a link between your radio transceiver and a simple data terminal (or personal computer). This Terminal Node Controller (TNC) allows you to operate new computer-based communications mode - "Packet Radio". You will find this unit convenient, and easy to use.

The most unique and important feature of packet radio transmissions, unlike RTTY, is that they are virtually error free. Information that you intend to transmit is first made into digital groups, or packets. Confirmation of correct reception of these packets is then returned to the originating station by the destination station. If the originating station does not receive confirmation, it automatically resends the packets until the correct information is confirmed, or the contact is terminated.

A modem (modulator / demodulator) that can operate at very high baud rates is included in the unit. This results in very short transmissions by each station, and allows several stations to use the frequency at the same time. Also, due to the choice of operating parameters, you are not aware of the presence of other stations on frequency.

The unit also functions as an automatic repeater. You may use it as an unattended repeater, a beacon, or a " mailbox " with the appropriate computer and software. You may also use it with an FSK or AFSK FM station on the VHF and UHF bands.

✓ In addition to your radio equipment, you will need either an ASCII data terminal or a personal computer that has an RS-232C output and uses a terminal emulator program. Such programs are widely available for connecting your computer to a modem like the Hayes Smart modem; They are often used to access CompuServe, GENine or other computer telephone services.

The demonstration terminal software supplied with the AR-210 package is for the IBM PS/2 , PC/XT/AT and compatible computers.

A 9 pin straight computer cable supplied with the AR-210 is for the IBM AT or compatible computers, but you may need a different cable and connectors if the supplied cable does not fit your computer.

## SPECIFICATIONS

Processor	Z80A, soft-compatible Application Specific Integrated Circuit. TMPZ84C015BF-6
Memory Backup	Lithium battery.
Serial Port	RS-232C interface to terminal or computer.
Baud rates	300, 600, 1200, 2400, 4800, 9600 and 19200. The default, or reset, baud rate is 1200.
Commands	TAPR TNC-2 up-load compatible.
Modem Port	1200 baud FSK
Protocol	AX.25 Level2, Version 1.1.4TE
Power Requirements	External 10 to 13.8 VDC at 200mA. (55mA from internal 4.8 volt, 120mAH Nicad battery. )
Input Level	20mV to 2V peak to peak, 18 $\Omega$ .
Output Level	0 to 300mV (variable).
Push-to-talk	30V maximum at 100mA
Overall Dimensions	2-1/2" W x 1"H x 1-1/4" L
Net Weight	3.3 oz.

*AOR, Ltd. reserves the right to discontinue products and changes specifications at without incurring any obligation to incorporate new features in products previously sold.*

## 1. INSTALLATION

Before you can perform the " Operational Test and Alignment ", which follows in this section , you will have to properly connect your AR-210 (thereafter called TNC) to a terminal or a computer, and run the proper terminal emulation program.

In addition, you will have to connect the TNC to your radio equipment, read and comply with the following information that pertains to your situation under "Computer Connections", "Software Requirements", and "Radio Connections".

If you use a computer you will need a terminal emulator, or communications program such as Procomm, Procomm Plus or accessory terminal program that comes with MS Windows.

A sample terminal program supplied with the TNC can be used for the IBM PS-2, PC, XT, AT and compatible computers running under MS DOS.

✓ Since these programs allow a computer to operate like a terminal, the following information will use the term "Computer" to refer to a computer or a terminal.

The TNC communicates with your computer through a serial port using signals that correspond to the RS-232C standard. Most computers that are available today either incorporate an RS-232C style serial port, or have one available as an accessory. If you have already been using your computer with an RS-232C modem, you can use this TNC the same way.

### COMPUTER CONNECTIONS

Table 1-1 shows the minimum connections that are required between the RS-232 I/O connector on the rear of the TNC and your computer. These minimum connections do not permit hardware flow control. **DO NOT connect any wires other than pins 1 through 8 and 20 if your computer I/O is a DB-25 style connector.** Pins 17 through 19 and 21 through 25 are reserved for future use.

The supplied cable is for the IBM PS/2, AT and 100% compatible computers with DE-9S asynchronous communication port (serial port) connector.

You may also consider using a 9-to-25 pin adaptor for connecting to a 25-pin serial port computers such as the IBM PC, XT and compatibles.

✓ **IMPORTANT** : Whether you purchase a ready-made cable or make your own, make sure that it is a **SHIELDED** cable.

**Table 1-1**

Pin	Signal Name	Description
2	Receive Data	Data from AR-210 to computer.
3	Transmit Data	Data from computer to AR-210.
5	Signal Ground	Common ground for both data lines.

It is beyond the scope of this manual to show you how to connect your TNC to every brand and model of computer. It does however, provide you with information for several common computers. If your particular computer is not listed, you can probably adapt the information that is presented to suit your needs.

## IBM

Table 1-2 and 1-3 shows the proper cable connections for IBM PS/2 , AT and compatible computers using 9-pin serial port. Use a 9-to-25 pin adaptor for connecting IBM PC, XT and compatible computers with a 25-pin serial port.

**Table 1-2**  
**IBM PS/2 , AT and compatible computers**  
**Computer with DE-9S Connector**

Computer	Signal name	AR-210
1	Carrier Detect	1
2	Receive Data	2
3	Transmit Data	3
4	Data Terminal Ready	4
5	Signal Ground	5
6	Data Set Ready	6
8	Clear To Send	8

**Table 1-3**  
**IBM PC/XT and compatible computers**  
**Computer with DB-25 Connector**

Computer	Signal name	AR-210
1	Chassis Ground	5
2	Transmit Data	3
3	Receive Data	2
5	Clear To Send	8
6	Data Set Ready	6
7	Signal Ground	5
8	Carrier Detect	1
20	Data Terminal Ready	4



## APPLE MACINTOSH

Table 1-4 shows the proper cable connections for an Apple Macintosh computer. This computer uses an RS-422 serial port. It will operate properly with your TNC. Although Pin 1 is not connected inside the computer, we recommend that you connect pin 1 to the main ground of the computer.

Table 1-4  
APPLE MACINTOSH

Computer	Signal name	AR-210
1	Chassis Ground	5
3	Signal Ground	5
5	Transmit Data	3
6	Data Terminal Ready	4
7	Carrier Detect	1
9	Receive Data	2

## OTHER COMPUTERS WITH 25-PIN RS-232C PORTS

If your computer has a 25-pin RS-232C port, refer to its manual to determine the transmit data, receive data, and signal ground pins. Follow the manufacturer's recommendations for connecting the serial port to a modem.

Your TNC is configured as Data Communications Equipment (DCE), while most computers are configured as Data Terminal Equipment (DTE). If this is true of your particular computer, you can probably connect pins 2, 3, and 5 of your TNC to pin 3, 2 and 7 respectively of your computer's RS-232C port.

If your computer is configured as DCE, you will have to cross the wires between pins 2 and 3 of the TNC. In other words, connect pin 2 of the TNC to pin 2 of the computer and pin 3 of the TNC to pin 3 of the computer. The signal ground is the same (pin 5 of the TNC to pin 7 of the computer).

Some computers may require that you connect pin 5 of the serial port connector to an appropriate signal. Others may require connections to pin 8 and 20. You can use the computer's output signals on pin 4 and 6 for this purpose as shown in Table 1-5.

Table 1-5  
Other computers with 25-pin RS-232C port

Computer	Signal name	AR-210
1-7	Signal Ground	5
2	Receive Data	3
3	Transmit Data	2
4 - 5	Jumper Pin 4 and 5	
6 - 8 -20	Jumper Pin 6, 8, and 20	

## OTHER COMPUTERS WITH NONSTANDARD SERIAL PORT

Computers with nonstandard serial ports must meet the following conditions:

1. The signal levels should be RS-232C compatible. The TNC requires that the voltage levels that come from the computer be greater than +3 volts in one state and less than 0 volts in the other state.
2. The polarity of the signals must conform to the RS-232C standard. A lower voltage state must correspond to a logical "1" and the higher voltage state to a logical "0".
3. The computer must be able to correctly receive a signal which meets the RS-232C specification. The TNC supplies signals that meet this specification.

Make or purchase a cable that provides the necessary connections. The serial port common pin must be connected to the TNC's serial port connector at pin 5. The data line that sends data **FROM** the computer must be connected to the TNC's connector at pin 3. The line that your computer uses to **RECEIVE** data must be connected to the TNC's connector at pin 2.

If your computer requires any other signals, you must find ways of providing them. The documentation provides with your computer or its accessory serial port should specify any special requirements of your particular port.

## SOFTWARE REQUIREMENTS

Any software package that enables your computer to act as an ASCII terminal with an ordinary telephone modem should work with your TNC. If you have a program that you have successfully used with a telephone modem, and you are familiar with its operation, use that same program to communicate with the TNC.

## WINDOWS TERMINAL

The Window terminal in the Windows version 3.0 or higher will work properly with your TNC. In the accessory group, chose the Terminal icon.

From the Setting menu, choose Communications, the communications dialog box should appear. Select the options according to the following list. Then choose the OK button.

Baud Rate	1200
Stop Bits	1
Parity	Even
Flow Control	Xon / Xoff
Connector	COM 1 or COM 2

## APPLE MACINTOSH

The MACTERM program will work properly with your TNC. Load this program and set the options as follows:

Compatibility	Terminal
1200 baud	VT-100
7 bits/character	ANSI
Even parity	UNDERLINE
Handshake Xon/Xoff	US
Modem connection	80 Columns
Telephone port	ON LINE
	AUTO REPEATE

## RADIO SHACK

The Radio Shack Model 100 and 200 has a built-in terminal program in ROM. Set the TELECOM parameters by typing { F3 } 57E1ENN [ Enter ]. Refer to TELECOM Manual supplied with Model 100 or 200 for further information.

## OTHER SOFTWARES FOR TNC

There are some ham radio groups or individuals who wrote some unique software for packet communications. In particular, the Tucson Amateur Packet Radio Corporation (Non-Profit Research and Development Corporation) where the TNC's original protocol was created, offers a variety of information and software for packet radio users. For further information of the TAPR, contact : Tucson Amateur Packet Radio - P.O.Box 12925 Tucson, AZ 85732 Phone 602-749-9497 Fax 602-749-5636. You may find some interesting topics from Packet Status Resister, the quarterly newsletter from TAPR.

## SAMPLE TERMINAL SOFTWARE

If you do not own any terminal software, use the sample diskette supplied with the AR-210. This sample software works under MS-DOS or PC-DOS only. The diskette also contains source code for a sample terminal program written by the MS. QBasic which can be run through the QBasic program comes with MS DOS 5.0.

## SAMPLE TERMINAL SOFT OPERATING PROCEDURE

1. Turn ON your computer.
2. Insert the diskette into drive. (A or B)

3. From the computer prompt, type **TERM** [Enter]  
If you use a Hard Disk, from the **C:\** prompt, type **A: TERM** [Enter].
4. The communication screen should appear .
5. The default parameters are 1200 baud/7 bits/Even Parity/One stop bits. Hit **P** while holding [Alt] key. Use the Arrow key to change the parameter.

## RADIO CONNECTIONS

Refer to Figure 1-1 while you read the following information. Depending upon your particular radio, you can either use the RADIO socket or the SP IN and MIC/PTT sockets. In general, the RADIO socket is for connection to a base or mobile station and the SP IN and MIC/PTT sockets are for hand-held transceivers that use a combination audio and PTT cable.

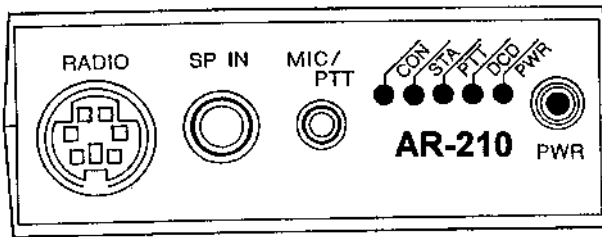

**Figure 1-1**  
**AR-210 Front Panel**

Figure 1-2 shows the connections for the RADIO socket. A cable that has a matching connector on one end fit this socket is provided. You will have to adapt the other end of the cable to fit your particular radio.

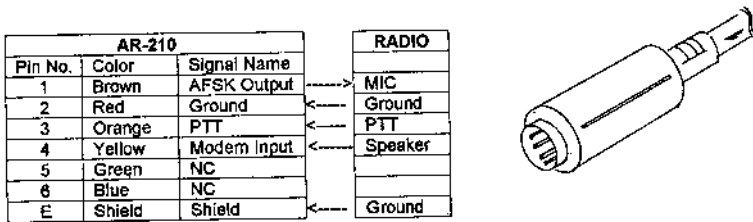

**Figure 1-2**  
**Miniature DIN style connector**

Two cables are provided for use with hand-held radios. One of these cables (for the SP-IN socket) has miniature phone plugs on each end and the other cable (for the MIC/PTT socket) has subminiature sockets on each end. These cables should interface properly with many of the popular hand-held radios that are currently available.

### TRANSCEIVER WITH MINIATURE & SUBMINIATURE JACKS

Most of the portable hand-held transceivers which have miniature phone jack (SPEAKER OUTPUT) and subminiature (MICROPHONE INPUT) should work with the TNC with no special modifications. (Except portable transceivers manufactured by YAESU. - Refer to the adjustments section of this manual.)

Connect the cable that has the miniature phone plugs (the larger plugs) between the SP IN socket on the controller and the speaker output socket on your transceiver.

Connect the cable that has the subminiature phone plug (the smaller plugs) between the MIC/PTT socket on the controller and the microphone/Push-to-talk socket on your transceiver.

Some transceivers use a miniature jack for MIC/PTT socket and a subminiature jack for speaker output. If this is a case, you must furnish your own cable.

Cut the two shielded cables in half, then connect and solder the free end of a cable that has a miniature plug (the larger plug) to the free end of a cable that has a subminiature plug (the smaller plug). Tape over the soldered connections to prevent a short circuit.

#### Typical Connections

Example: ICOM, KENWOOD, ALINCO,  
YAESU (Modification on the TNC is required.)

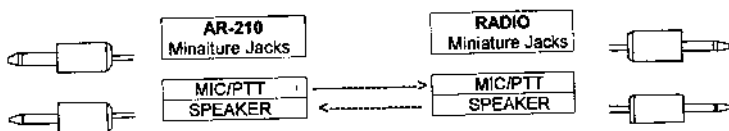

Example: YAESU (Mobile radio.-Some model requires Diode instead of pull-up resistor.)

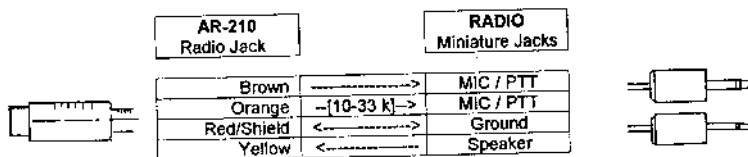

Example: Mobile and Portable transceivers with multi-pin jack.

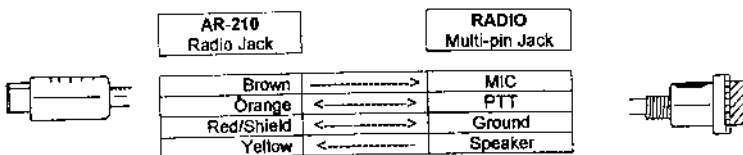

Example: Portable transceiver with stereo type jack, ALINCO [Some portables]

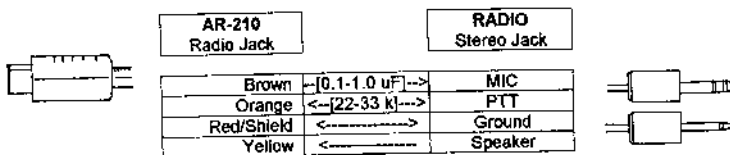

## POWER SOURCE

To power your TNC, you will either need the NiCd battery pack or an external power supply. An external power supply must be able to provide 10 to 13.8 VDC at 100mA. If you install the NiCad Battery pack and wish to charge it's battery from your external power supply, the power supply should be able to provide at least 200mA. The plug which comes with the AC power adaptor should be the matching plug and polarity. Refer to Figure 1-3.

Figure 1-3

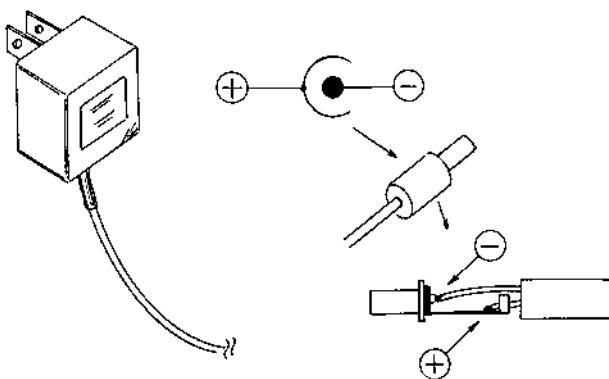

## NICAD BATTERY

The AR-210 is designed to operate on a 4.8 V DC Nicad battery pack. The following steps show you how to instal the optional Nicad Battery pack in your TNC.

1. Turn the controller off and disconnect any external power supply.
2. Refer to Figure 1-4 and remove the screw from the bottom of the unit. Then carefully remove the bottom cover.
3. Plug the socket coming from the Nicad Battery pack to the connector on the circuit board. The socket is keyed to fit only one way.
4. Insert sponge between the battery and circuit board.
5. Use the screw you removed earlier to reinstall the bottom cover.

Figure 1-4

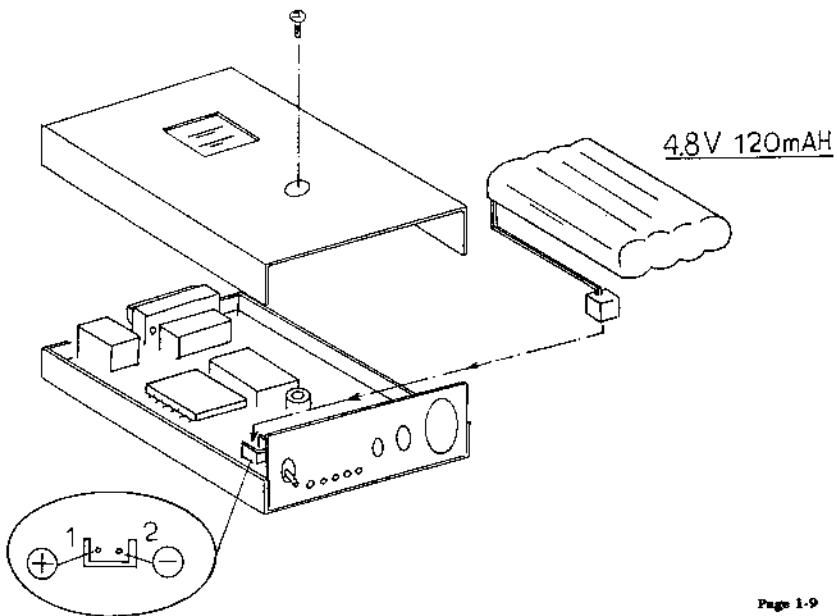

Page 1-9

## 2. OPERATIONAL TESTS AND ADJUSTMENT

This section of the Manual describes some operational tests you can perform to make sure your TNC is connected and operating properly.

### PRELIMINARY TESTS

Make sure you have the TNC connected to a suitable power source. Also make sure you have the TNC connected to your computer as described in the "INSTALLATION" section of this manual.

1. Turn the computer on and boot up any necessary terminal emulation program.
2. Turn the POWER switch ON. The PWR LED should light. Some of the other LEDs may light briefly and then extinguish.

If your computer's data rate is set to 1200 baud, you will see the following messages:

```
AOR data controller AR-210
AX.25 Level 2 Version 2.0
Message board Ver 1.28E
Release 15-Mar-92
Checksum $ F4
cmd:
```

- ✓ If your computer's baud rate is set to something other than 1200 baud, you will see meaningless characters.

### ADJUSTMENTS

The following steps check the basic operation of the controller.

1. Make sure your radio is connected to the controller as described in the "Operation" section of this Manual.



2. Type " MY W6YEY " followed by a [ RETURN ], substituting your call sign in place of the one shown. Your monitor should reply with.

cmd: W6YEY  
MYCALL was NOCALL

3. If your radio had a squelch control, un-squelch your receiver.
4. Advance the receiver's volume control until DCD LED (Green LED) on the controller just lights when no signals are present. This is the proper initial setting of the receiver's volume control.
5. Turn the radio's squelch control until the DCD LED just extinguishes.
6. Listen for packet activity and readjust the receiver's volume control as necessary until you receive packets properly.

✓ The output level from the controller has been factory set at 150 mV peak-to-peak, which should be satisfactory for most radios. If however, you find that this is not correct for your radio, perform the steps as described on the next page.

#### AUDIO LEVEL ADJUSTMENT

1. Remove the screw from the bottom of the controller. Then carefully remove the cabinet bottom.
2. Refer to Figure 2-1 and locate control VR3, on the circuit board near the TCM-3105 modem chip. Then adjust this control as necessary for proper output level.
3. Reinstall the cabinet bottom on the controller.

#### PTT LINE ADJUSTMENT

If during the operation of your TNC you find that the TNC does not operate your radio's PTT circuit, carefully remove the cabinet bottom as discussed here, and remove two screws from the PC board. Then refer to Figure 2-1 and apply a small amount of solder to short the tiny foil solder pads. Reinstall the PC board and cabinet.

Figure 2-1  
AR-210 CIRCUIT BOARD

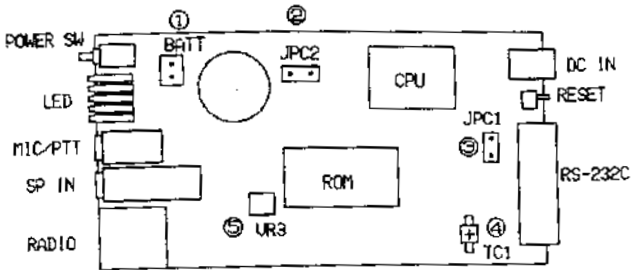

- (1) BATT : Connector for an optional Nicad Battery.
- (2) JPC2 : Disable Battery Back-up. (Hard Reset)
- (3) JPC1 : Remove this jumper to output DCD voltage at Connect state.
- (4) TC1 : Adjustment for internal clock.
- (5) VR3 : AFSK output adjustment.

**SOLDER BRIDGE**  
(For YAESU etc.)

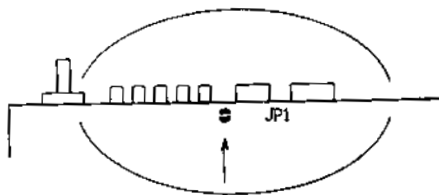

### 3. OPERATION

Figure 3-1 shows the front panel of your TNC and briefly describes each LED, switch, and connector. The following pages describe the operation of the unit, and how to use the TNC to receive and transmit "packets".

Before you attempt to use the TNC, be sure you are thoroughly familiar with your communications equipment and its operation. This equipment should either be crystal-controlled or synthesized to ensure excellent frequency stability, which is important for packet radio operation. Be sure the transmitter you use has the ability to handle "key down" operation. Also, be sure you are familiar with your computer terminal or computer (used in the terminal mode) and its operation.

- ✓ 1. After the TNC types the sign-on message on your terminal, you are ready to operate.
- 2. You can use your computer to emulate a terminal by running a terminal emulator program. A terminal emulator program makes the RS-232C port on your computer appear as a terminal input to the TNC.

#### GENERAL

Your TNC uses AX.25 software (built into ROM) and has following operating modes:

**Command Mode** - In this mode, everything you type is interpreted as instructions for the TNC. These instructions are in the form of command lines that are terminated by a **RETURN**. The commands allow you to change the TNC operating parameters, perform special functions, or change modes. If your TNC receives packets while it is in the Command Mode, you will see it printed on the display screen. To send packets, you must direct the TNC to enter the data mode.

**Data Modes** - Two data modes are available; the Converse Mode and Transparent Mode. In these modes the information you type to the TNC is assembled into packets and transmitted on the radio.

The remainder of this section first describes the terminal you will use. It then explains how to use the commands to configure the TNC to suit you and your station, and how to get started talking to other stations on packet radio.

Figure 3-1

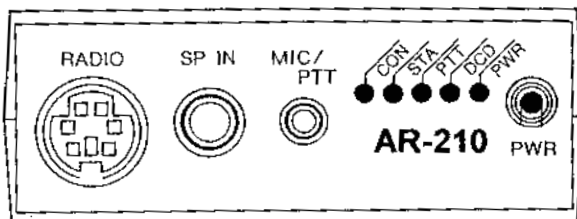

RADIO	Jack	Socket connection of a base or mobile radios.
SP IN	Jack	Input connector for receiver audio from hand-held radios.
MIC / PTT	Jack	Audio output and PTT connector for hand-held radios.
CON	LED	Lights when the TNC is connected to another station.
STA	LED	Lights when the TNC still has data to transmit.
PTT	LED	Lights when the TNC is sending transmit data.
DCD	LED	Lights when the TNC receives a signal.
PWR	LED	Lights when the TNC is turned on.
PWR	Switch	Power On/Off switch.

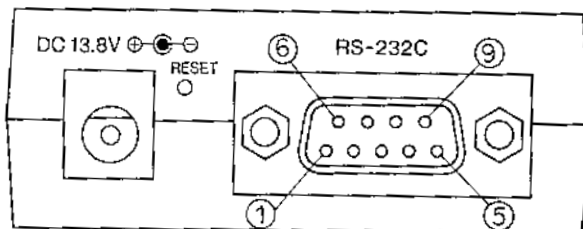

DC INPUT	Jack	For connection of an external power supply or a charger.
RS-232C	Jack	For a connection of a computer or terminal.
RESET	Switch	Hard rest switch.

This is not intended to be an exhaustive description of every command, but rather a discussion about how the various commands are related and how you may use them. An alphabetical catalog of commands that describes the format and parameters of each is provided in the document file in the attached diskette. Refer to section 4, "COMMANDS AND MESSAGES" of this manual to access the disk file.

## TERMINAL CHARACTERISTICS

**Baud Rate Selection** - Most terminal use serial communications. In this mode, each bit 7- or 8-bit character is sent in sequence over the same wire. Serial data must be transmitted at a predetermined bit-per-second rate called baud rate. There are many standard baud rates. Unless the TNC and the terminal use the same baud rate, they will not be able to communicate. This TNC supports the following standard baud rates: 300, 600, 1200, 2400, 4800, 9600 and 19200.

**Word Length/Parity/Stop Bits** - In addition to the data rate, there are three other characteristics of serial data which should be the same of TNC and the terminal. These are word length, parity, and number of stop bits. Use the commands **AWLEN** and **PARITY** to set these characteristics. Serial data may represent ASCII data, which has seven data bits per character, or binary data, which has eight data bits per byte. Unless you operate in the Transparent Mode, the TNC will ignore the extra bit if you use 8-bit characters. This means that the eight bit is set to 0 before data is assembled into a packet.

- If you change any of these configurations, the new values do not take effect until you perform a reset by turning the power off, or type **RESTART**.

If you start the TNC in the default-parameter mode, the serial port is initialized at 1200 baud, even parity, 7-bit characters, and one stop bit. A message is then typed at 1200 baud.

## GETTING STARTED

After you have your TNC and terminal set up properly, you should see the TNC sign on with a message, followed by the command prompt:

**cmd:**

When you see this prompt, first set your call sign. To do this, type **MY** and your call sign as shown below :

**cmd: MY W6YEY <RETURN>**

A lithium battery inside the TNC enables it to remember any changes you make in the default parameters.

Once you set your call sign, you are ready to send a packet. First type the command **CONVERS** and press **<RETURN>** to enter the converse mode. Then type a message you wish to transmit as a packet:

**THIS IS A TEST I**

Press the **RETURN** key to end your message. If you watch the LEDs on the front of the TNC when you do this, you should observe the following.

1. The STA light will light, indicating that the data is received from the computer. The PTT LED may also light briefly at the beginning of the transmission.
2. When the transmission stops, the PTT LED will extinguish.

The message you just transmitted was sent to the address specified by the **UNPROTO** command. This address is set to **CQ** when you first turn the TNC on or type **RESET**.

To find out which stations in your area use packet radio, make sure the monitor function is turned on. To do this, first type **CTRL-C** ( press and hold down the control key while you press the **C** key ) to return to the command mode, if this has not already been done. Then type each of the following commands:

**cmd: M ON <RETURN>**

**cmd: MA ON <RETURN>**

✓ Refer to " 4. COMMANDS AND MESSAGES " beginning on Page 4-1 for information about these commands.

Any packet that your TNC receives should now appear on your screen.

To make full use of the TNC's capabilities for reliable data communications, you should establish a connection with another station.

This causes everything you type in the Converse Mode to be automatically addressed to the other station, and packets sent between your station and the other station will be automatically acknowledged by the recipient.

The sending station will continue re-transmitting the message, a preset number of times, until it has been received properly. To connect to **W6UOU**, for example, type **CTRL-C** followed by a **<RETURN>** to return to the Command Mode (if this has not already been done. Then type :

**cmd: C W6UOU <RETURN>**

If **W6UOU** is on the air, tuned to your frequency, and within range of your transmissions, you should see a message coming back to your TNC. If you have a speaker as well as your TNC connected to your radio, you will hear the packets. Whether you have a speaker connected or not, you should see the DCD LED light with each incoming packet. When you request a connect ( the packet your TNC sent ) is acknowledged, the TNC will display the following message:

**\*\*\* CONNECTED TO W6UOU**

The TNC will then switch to the Converse Mode. If you now type a message, it will be formed into a packet and stored in memory until you press the **RETURN** key. At that moment, it is sent to **W6UOU**.

After you complete the conversation, either you or the operator of the other station may initiate a disconnect. To do this, return to the Command Mode (by typing **CTRL-C**) and type the following command:

**cmd: D <RETURN>**

After an exchange of packets, you will see the message:

**\*\*\* DISCONNECTED**

This message indicates that your disconnect request packet was acknowledged by the station you were connected to.

✓ You must send a disconnect request to the station you are communicating with before you can connect to other stations or hear them (if your monitor functions are set to off).

When you become familiar with packet radio, you can learn how to use the **STREAMSW** command to connect to more than one station at a time.

If you are ready to receive messages from other packet radio stations and you wish to let them know that you are active on packet radio, you can use the TNC as an automatic repeater (or beacon) to transmit this fact at preset intervals.

You must first decide how often you wish your station to send the desired message, and then store it in RAM inside your TNC. If, for example, you wish to send it every 30 minutes (or every 1800 seconds), type the following after the command prompt:

**cmd: B E 180 <RETURN>**

✓ You must divide the number of seconds by 10 before you enter the desired time.

The TNC will respond with a message similar to :

**was EVERY 0**

If no number was previously entered in RAM, or the number that corresponds to the number you may have entered earlier.

Then type **BT** followed by the message you wish to send.

Example: **BT W6YEY LOS ANGELES CALIFORNIA**

The TNC will respond with a message similar to:

**was**

✓ In this case, no text message was previously entered. If a message was previously entered, it would follow the word "was".

If **W6WNE**, for example, "hears" your beacon and wishes to contact you, he will type:

**C W6YEY <RETURN>**



When your TNC acknowledges his connect request, it will display the following message:

**\*\*\* CONNECTED TO W6WNE**

Your TNC will then switch to the Converse Mode. If you now type a message, it will be found into a packet and sent to **W6WNE**.

Since you have now succeeded in getting your packet radio station on the air, read the following pages which describe the TNC operation in more detail. The remainder of this section will help you get the most out of your TNC.

## **OPERATING MODES**

### **COMMAND MODE**

Use the Command Mode to enter commands that alter the TNC's operating parameters. You must enter all other modes from the Command Mode. When the TNC is in the Command Mode, "cmd:" appears on the screen at the beginning of each input line. This indicates the TNC is waiting for instructions.

The TNC is always in the Command Mode after a reset or power-up. You can perform reset by pushing the **RESET SWITCH** or by issuing a **RESET** command. After a reset operation, all operating parameters of the TNC are re-initialized by the resident software.

There are several ways you can get from the Command Mode to one of the data modes. You can type the command **CONVERSE** or **TRANS**, depending upon the data mode you desire. This cause an immediate mode change. If you issue a **CONNECT** command to initiate a conversation with another station, or if your TNC receives a connect request packet, the TNC will automatically change to a data mode after the connection is established. The setting of the **CONMODE** parameter determines whether the TNC will enter the Converse or Transparent Mode. If you specify the data mode in the **CONNECT** command, however, that mode will be used without altering the setting of **CONMODE**.

### **DATA MODES**

#### **a. Converse Mode**

The Converse Mode is the data mode that you will probably use most for ordinary contacts. In this mode, the information you type is assembled by the TNC into packets and transmitted over the radio.

A packet is terminated whenever you type the send-packet character, which is set by the **SENDPAC** command, and may optionally be included in the packet. There are nine characters that have special meanings to the TNC. These characters allow you to correct typing errors in your messages and return to the Command Mode, but are not normally included in the packet. These included input editing characters, which are discussed in a later section.



To return to the Command Mode from the Converse Mode, just type **CTRL-C**.

### **Transparent Mode**

Packet radio is very well suited for transferring large amounts of data between computers. For some types of data transfer operations, the Converse Mode will work very well.

You may want to send special information, however, such as ready-to-run programs to another station. A .COM file on a DOS system or even BASIC program may contain many strange characters which could be confused with special characters in the Converse Mode. For this application, you will want to use the Transparent Mode (a data mode like the Converse Mode, except there are no special characters).

Everything you type, or everything your computer sends to the TNC, is sent over the radio exactly as it appears to the TNC.

Packets are sent at regular time intervals or when a full packet of information is ready. You may use the **PACTIME** command to change the time intervals at which data is put into packet form.

The display characteristics of the TNC are also modified in the Transparent Mode. Data is sent from the TNC to the terminal exactly as it is received over the radio channel, including all eight bits of each byte received. All features such as **LINE FEED** and **RETURN** insertion, **ESCAPE** translation, and case conversion are disabled. None of the parameters which control these features in the Converse Mode are changed when you enter the Transparent Mode, and all display features are re-enabled when you return the TNC to the Command Mode. Most of the informative messages that appear in the Converse Mode as the TNC moves between the disconnected and connected states are also disabled.

If you wish to escape from the Transparent Mode to the Command Mode, you must use the following special procedure.

✓ After a time equal to **PACTIME** has elapsed, the last data you typed will have been put into packet form for transmission (although it may not have been transmitted yet).

1. Wait for **PACTIME** to elapse. Then wait an additional time, which is set by the **CMDTIME** command.
2. Type **CTRL-C** three times within an interval **CMDTIME** of each other.

After a final **CMDTIME** interval in which you did not type any characters, you will see the "cmd:" prompt. If you type any character in this interval, even if they are more command characters, the escape will be aborted and the three command characters will be sent as packet data. If you set **CMDTIME** or **PACTIME** to 0, you will not be able to escape from the Transparent Mode except by performing a hard reset (power-down reset).

## FLOW CONTROL

Whenever you transfer data to computer, there is a chance that the data will be received faster than the computer can handle it. To prevent loss of data, the computer must be able to make whatever is sending data stop sending, and later tell it to resume sending.

If you are a home computer user, you are probably already familiar with one type of flow control, which allows you to stop the output from the computer while you read it and restart it when you have finished.

There are two methods of providing flow control that are supported by the TNC, XON/XOFF flow control, sometimes called "software flow control", is accomplished by sending a special character (usually a **CTRL-S**) to request that the output stop and another special character (usually a **CTRL-Q**) to restart the output.

Hardware flow control may be used if both computers use the RTS (Request To Send) and CTS (Clear To Send) lines of the RS-232C interface.

Many terminal programs and file transfer programs for home computers do not implement flow control in software, and may so-called RS-232C ports do not support hardware flow control.

Even if the RTS and CTS lines appear at the connector, software that directly reads the CTS line may be required in order for flow control to be implemented. If you find that the TNC's seem to lose data during file transfers, immediately suspect a flow control problem.

## **XON/XOFF FLOW CONTROL**

If you are using a terminal rather than that a computer, or if your computer does not support RTS/CTS flow control, you can use XON/XOFF flow control. You can establish this method by setting **XFLOW ON**. The special flow control characters are set to **CTRL-S** and **CTRL-Q** by default.

In the Command Mode, the TNC input buffer may fill up if you try to type too long a command. In the data mode, the buffer may fill up if you are using your computer to transfer data at a rate that is faster than the data rate for radio transmission, if radio data transmission has slowed down due to noise or other users on the channel, or if the operator or computer at the other end has stopped the output from his TNC.

The TNC will send the terminal an XOFF character when there is room remaining for about ten characters in the buffer. If you continue sending data until there are only five spaces left, the TNC will send an XOFF character after each character received. When the buffer fills up completely, data will be lost. When the buffer empties out, the TNC will send a single XON character to the terminal.

If you disable **XON** and **XOFF** by setting them to 0, the TNC will automatically use the RTS/CTS flow control to stop input from the terminal.

XON/XOFF flow control is normally disabled in the Transparent Mode. This is done because characters are treated as data; therefore, the XON and XOFF characters will not be recognized.

If you cannot use RTS/CTS flow control, you may enable the XON and XOFF characters (the commands from the TNC to the terminal) by setting **TXFLOW ON** and **XFLOW ON**. **START** and **STOP** characters (the commands to the TNC from the terminal), however, will still be treated as data.

## **HARDWARE FLOW CONTROL**

This method of flow control is preferred, since it usually does not depend on the programming of a particular communications program.

The AR-210 conforms to the TAPR TNC-2 standard which uses DTR (Data Terminal Ready) instead of RTS (Request To Send).

If you wish to use DCD (Data Carrier Detect) signal to control your software or your software requires DCD On/Off, Remove JP-1. If you remove the JP-1, the TNC will provide +8VDC for connected state and -8VDC for non-connected state. Refer to the figure 2-1 for the location of JP-1.

## DISPLAY OPTIONS

Several parameters control the way output is formatted for display on your terminal. Most of these are parameters that are determined by the display capabilities of your terminal and changes only if you change terminals.

In the Converse Mode, it is natural to choose a line-termination character such as a <CR> or <LF> to terminate packets. For some applications, however, you may want to use an "invisible" command character to force the TNC to transmit a packet.

In the first case, the send-packet character is interpreted as part of the input as well as a command; in the second case, it is a command only. You can choose either option with the **CR** command. If **CR** is **ON**, the send-packet character is data, and is echoed to the terminal and included in the packet. You should disable **CR** if you are using packet time-out (**CAPACITIME ON**) in the Converse Mode.

A common occurrence when two stations are exchanging packets is for incoming packets to arrive when the operator is in the middle of typing a line. In order to prevent the new line from disrupting the screen display, you can enable **FLOW**. In this mode, output to the screen is disabled as soon as you begin to type, and is enable when a packet is completed.

If you want to see the incoming packet before you transmit your line, you can type the re-display-line character, which is set by the **REDISPLA** command (default **CTRL-R**).

This will display the incoming packet and then retype your partially completed line. If **FLOW** is **OFF** and an incoming packet disrupts your typing, you can also use this character to re-display your input line.

The **SCREEN** parameter sets the width of the terminal screen on page. Whenever this number of characters has been set to the terminal without an intervening <CR>, a <CR> is inserted in the output. A <CR> is also echoed if you type a line that exceeds the width of your screen; the extra <CR>, however, is not included in the packet.

If your terminal performs automatic line-wrap, you should disable this feature by setting **SCREENLN** parameter to 0. The TNC does not carefully distinguish between printing and non-printing characters and it does not correct its line count for horizontal tab characters; backspace characters, however, are counted correctly.

For normal display, a <CR><LF> is the new line sequence. You terminate a line, however, by typing with a single character, usually a <CR> (called RETURN or ENTER on some terminals.)

If only a <CR> is displayed, the next line will be typed over the previous one instead of appearing below it. Some terminals automatically display an <LF> following each <CR>, but most do not.

If auto line feed is enabled by **AUTOLF** (default ON), the TNC will add a <LF> after every <CR> displayed or echoed.

The conventional response to character deletion on a display terminal is to feed a backspace - space - backspace sequence to the terminal.

This removes the character from the screen and leaves the cursor ready to type a new character in its place. On a hard-copy terminal, however, this results in unreadable text.

If backspace display is disabled with **BKONDEL OFF**, a backslash symbol (\) will be displayed for each character deleted. You can use the re-display line character to see the corrected line.

The <ESCAPE> character (ASCII code 27 or hexa-decimal \$1B) is used by many terminals to control cursor movement and special display mode.

✓ Throughout this Manual, the dollar sign symbol, \$, prefaces all hexa-decimal numbers.

If you do not want this effect, enable the <ESCAPE> translation with **ESCAPE OFF**. This will cause all <ESCAPE> characters to be sent to the TNC as the dollar sign symbol. This does not affect <ESCAPE> characters that are transmitted as packets.

Some terminals echo characters typed in locally, before the character is transmitted to the I/O port. Also, some terminal programs on computers may perform local echoing.

If the TNC also echoes characters, you will see two of every character. You can disable the echo mode by setting **ECHO** to **OFF**.

A few terminals require particularly long time to respond to <CR> or <LF>. Some hard-copy terminals require time to move the printer head to the beginning of the line following a <CR>.

Some display terminals require long times to scroll their screen following a <LF> character. If characters are sent to such a terminal before it is ready, the character will be lost.

If your terminal always loses a few characters at the beginning of a line, you need to enable null insertion. A null is character with ASCII code 0; and the TNC does not actually transmit nulls in this mode, since they are misinterpreted by some computer's terminal program as a BREAK signal.

The number of null intervals is set by the command **NULLS**, and null insertion after <CR>s and <LF>s is separately enabled by **NUCR** and **NULF**.

## EDITING COMMANDS

Several characters are used to correct mistakes in the text typed into the TNC. Except in the Transparent Mode or if times packets are in effect in the Converse Mode, no text characters are interpreted by the TNC until it receives a <CR> or the send-packet (in the Converse Mode). Until then, you can delete and retype characters or cancel the line completely.

Control characters are normally chosen as editing characters.

## SPECIAL OPERATING CONFIGURATIONS

The primary function on the TNC is to enable you to communicate with other stations via packet radio. The AR-210 implements the AX.25 protocol (set of rules).

This protocol is designed primarily for point-to-point, two-party communications. You can also use it, however, to simulate the common amateur net or round-table type of contact. You can specify the AX.25 protocol level 2 version by setting it **ON** (Level 2, Version 2.0) or **OFF** (Level 2, Version 1.0).

Earlier in this section, you learned how to set your call sign and issue the **CONNECT** command to take to a specific station. These commands are the beginning of packet operation, which you will now learn more about.

To establish a two-way connection, the TNC must know your station address and the address of the party you wish to talk to.

To prepare your TNC for radio operation, first establish your call sign as the station address by using **MYCALL** (or just **MY**) command. This sets the string that is used to identify packets transmitted by your station (the protocol will not work if there is more than one station on the air with a given address).

If you have more than one station operating using your call sign, you can give them different addresses using the station ID (SSID) extension, a number between 0 and 15. This number is appended with a dash like this:

#### MYCALL W6YEY-7

If you do not specify the SSID extension, it will be 0. The extension does not affect the ID of your station.

The call sign specified by MYCALL is ordinarily used by the TNC for station identification. This call sign is sent automatically every 9-1/2 minutes if your TNC is used as a digipeater in the previous 9-1/2 minutes. In many locations, the address string included in the packets may be considered adequate identification for legal purposes.

Automatic station identification is initially off, but you can turn it on by setting HID to ON. You can make the TNC send your call sign at any time by typing ID.

The AR-210 provides a real morse code station identifier, when you activate the CIDCON command. This command enables morse ID specified by the CWID text. The AR-210 generates Morse code at the speed of 20 wps. (word per second) using AFSK modem.

To active this feature, type your call sing into CWID text and set CIDCON for a specific time interval.

Example:

```
cmd: CWID W6YEY <RETURN>
```

```
CWID was
```

```
cmd: CIDCON EVERY 60 <RETURN>
```

```
CIDCON was EVERY 0
```

This example shows that the Morse code station identifier will transmit every 10 minutes interval.

You already learned about the CONNECT command, which causes your packets to be sent to a specific station. If the station you wish to talk to is a little too far away for you to connect directly, you can use the digipeating feature of the TNC.

A digipeater accomplishes much the same task as an ordinary repeater in extending the range over which you can communicate. The difference is that your messages are copied and relayed by the digipeating packet station.

This results in better quality of the signal received at the destination at the expense of some delay while the intermediate message is received and re-transmitted.



To request digipeating under the AX.25 protocol, you must specify the intermediate packet stations which you want to relay your messages.

You can do this as part of the **CONNECT** command by using the **VIA** sub-command:

**CONNECT W6YEY VIA W6WNE-7, W6UOU**

You must list the intermediate stations in the order in which you want them to relay the packets as they go from your station to the destination station. In this example, your connect message to **W6YEY** will be repeated by **W6WNE-7** and then by **W6UOU**. Reply packets from **W6YEY** will be relayed first by **W6UOU** and then by **W6WNE-7**.

You can specify as many as eight intermediate stations; however, keep in mind that using more than one digipeater is an extension to AX.25 and may not be compatible with other implementation of this protocol.

The delay between your transmission and the reception of a reply will naturally increase as more intermediate relays are used.

Also, the possibility of losing information due to interference or noise on the channel increases.

You can specify intermediate digipeaters to be used for unconnected packets by using the **UNPROTO** command with the same format as the **CONNECT** command:

**UNPROTO QST VIA W6WNE**

This causes packets sent when you are not connected to another station to be sent to QST (rather than the default CQ), digipeated by **W6WNE**.

For special applications, you can disable the TNC's ability to connect or to transmit. If you specify **CONOK OFF**, the TNC is prevented from accepting connect request from other station (although it does not stop you from initiating a connect request of your own).

If a connect request is received when **CONOK** is **OFF**, the TNC will send a "station busy" packet to the requesting station and display a message such as:

**\*\*\* connect request : W6WNE**

to identify the requesting station.

If the TNC receives a "station busy" message in response to a connect request, it will display a message such as:

**\*\*\* W6UOU station busy**

to show the call sign of the station you tried to connect to.

These messages are also used if a TNC is connected to another station when a request is received.

In addition to transmitting information typed in from a data mode, you can command the TNC to send a specific message at regular intervals. This message is called a "beacon".

You can use this function to send announcements to allow other packet users to test their equipment. To set the beacon text to your message, type the command:

#### **BTEXT**

Everything you enter on the command line following the space after **BTEXT** will be entered into your message string.

Use the **BEACON EVERY** command to set the interval between your beacon message. If you wish the beacon to transmit at 30-minute intervals, for example, give the command:

#### **BEACON EVERY 180**

You can specify any value between 0 and 255 for n in the **BEACON EVERY n** command, where n specifies 10-second time intervals. A value of 0 is the default value and turns the beacon off, while 255 specifies 2550 seconds ( or 42.5 minutes). If local activity is high on your operating frequency, it is wise to send regular beacon message at 30-minutes or longer intervals.

The beacon function also has a transmit-after mode, in which a beacon packet is only transmitted after activity is heard on the channel. You can use this feature to leave a message for other packet users.

If someone initiates a connection (or sends anything, for the matter) on an otherwise idle channel, a beacon can be sent a short time later with a message such as " I'll be back on the air on packet after dinner - call me then".

If some station is monitoring beacon packets (refer to the description of the monitor mode in the document file in the floppy disk supplied with the AR-210), the operator will see this message. No beacons are sent in this mode if there is a lot of packet activity on the channel, since the required period of quiet will not occur.

## PACKET TIMING FUNCTIONS

Four basic adjustable timing parameters are provided so you can configure the TNC to your particular radio environment. Some other parameters related to the timing parameters are also described.

The time delays that are required when the TNC switches from receive to transmit and from transmit to receive vary greatly among various radio equipment. When two stations send packets back and forth, these delays must be allowed for.

If data is sent before the transmitter is operating, the packet will not be transmitted properly. Similarly, if the receiving station has not had sufficient time since it stopped transmitting for the receiver to become active, data will be lost.

The delay between transmitter key-up and the beginning of data transmission is controlled by the **TXDELAY** command. Optionally, this parameter should be set to the same value by all members of a local packet group, and it should be determined by the slowest pair of stations in the group.

If you transmit packets through an audio repeater, you may require a considerably longer key-up delay than that required for direct communications. The **AXDELAY** command allows you to specify an additional key-up delay to allow the repeater receiver and transmitter to lock up.

If the repeater has a long "hang time" and stays up for a while after the other station has stopped transmitting, you can make use of this time with the **AXHANG** command.

If the TNC has detected channel activity recently enough that the repeater should be "up", it will wait only a time that equals the **TXDELAY** before it sends data, rather than adding an **AXDELAY** time as well.

The parameters set by **TXDELAY**, **AXDELAY** and **AXHANG** are all specified as numbers between 0 and 120 (Except **AXHANG** which has 0 to 250 range.) The actual delay in milliseconds is a multiple of the input parameter times 10 ms.

During the time the TNC is keying the transmitter but not sending data, it will transmit a synchronization signal (flags). Thus the total key-up delay will only be:

$$\text{Key-up delay (ms.)} = (\text{TXDELAY} \times 10) + (\text{AXDELAY} \times 10)$$

If channel activity has been heard more recently than  $AXHANG \times 10$  ms ago, the key-up delay will be:

Key-up delay (ms.) =  $TXDELAY \times 10$

If it takes your radio an exceptionally long time to key-up, you can use  $AXDELAY$  to augment the maximum delay available with  $TXDELAY$  by setting  $AXHANG$  to 0.

The AX.25 protocol provides for re-transmitting packets if no acknowledgment is heard from the connected station within a certain period of time. A packet may not be acknowledged due to channel noise or "collision" with another packet transmission.

Since there may be other stations on the channel, the receiving station may not be able to acknowledge the received packet immediately. The time lapse before the originating station retransmits and the originating station terminates the connection is set by the **RETRY** command.

The maximum number of transmissions of a packet is **RETRY** + 1, since the initial transmission does not count as a re-transmission.

The frame-acknowledge time is automatically corrected for the additional time required for digipeating.

An extra time delay is added for each transmission, which must be made after origination of the packet in order to deliver the packet and receive the acknowledgment. The time interval before the TNC transmits an unacknowledged packet is therefore:

Retry interval (Sec.) =  $FRACK \times (2 \times n + 1)$

where n is the number of calls in the digipeat field of the address.

The AX.25 protocol specifies that acknowledgment of digipeated packets be made from end to end. This means that intermediate digipeaters do not acknowledge the packets they digipeate. When the destination station receives the packet, it generates an acknowledgment which is sent through the reverse route used by the original packet.

If there are several intermediate relays, the chance of either the original packet or the acknowledgment being lost increases drastically. To help alleviate this problem, an automatic wait timer can be imposed on any station not transmitting a digipeated packet.

Any station ready to transmit a packet immediately after the carrier drops is required to wait for this time interval unless it will be transmitting one or more digipeated packets.

This means that the chance of a collision involving a digipeated packet is reduced since, once a transmission begins, other stations will wait for a clear channel.

The digipeat wait time is set by the **DWAIT** command, which specifies 10 ms intervals. If no digipeating is being done by anyone in the local area, you can set this parameter to 0. In any event, however, it should be set to the same value by all members of a local packet group.

The AX.25 protocol allows multiple packets to be transmitted before waiting for an acknowledgment. This permits more efficient channel use when large amounts of data are being transferred.

The maximum number of packets that the TNC will send before waiting for acknowledgment is specified by **MAXFRAME**. Of course, the TNC will not wait until **MAXFRAME** packets have been entered before transmitting - this parameter is only used to limit the transmissions if more than one packet is ready when the TNC begins to transmit.

**MAXFRAME**, in combination with **PACLEN**, determines how much information can be sent in a single transmission. The best combination for efficient data transfer is determined partly by the channel quality and partly by the rate at which the terminal can process data.

For 1200 baud terminal data rate, you should start with a combination that produces about 300 characters outstanding at one time.

## MONITOR FUNCTIONS

Although the AX.25 protocol is primarily oriented toward setting up "circuit" between two stations, this is not the way many packet users operate.

The TNC can also operate in a mode more suitable for a "net" or "round-table" discussion with several participants, although reliable reception of your transmissions by every station cannot be guaranteed. This is done by enabling the monitor functions.

Monitoring is enable by setting the **MONITOR** command to **ON**, and separate monitor functions are individually enabled. This set of functions allows you to see displayed packets from selected stations or classes of stations.

You can list up to eight call signs of stations to monitor or discard with the **LCALLS** and **BUDLIST** commands.

Packets are displayed if any of the call signs specified by **LCALLS** appear in the "yes" field of the packet address, or if any call signs specified by **BUDLIST** appear. If you specify **ALL** in place of an **LCALLS** list, you will see all of the packets your TNC receives.

✓ Since the **LCALLS** and **BUDLIST** commands interact, refer to their descriptions in the command list on the floppy disk which comes with the AR-210. To access the disk file, refer to "Commands and Messages" section of this Manual for additional information.

Monitored packet displayed is somewhat different from the display of connected packets. Each packet is displayed with the source and destination stations identified:

**W6YEY > W6UOU : Go ahead with the file transfer.**

If a connected packet QSO is taking place on the frequency of your group conversation, you may wish to ignore all connected packets while your group operates in an unconnected mode.

The **MALL OFF** command causes connected packets to be ignored. If you want to be able to monitor packet activity when your station is not connected but have the feature automatically disabled when you connect to someone, you should set the **MCON** command to **OFF**.

If you have **MALL ON** and **MCON ON**, and you are monitoring the station you are connected to, packets from that station will be displayed only in the monitor format and not in the usual manner with no station identification.

You can operate a group conversation with some data integrity by having the stations connect in pairs and set **MALL ON** and **MCON ON**. This does not insure that every packet is received at every station, but it does insure that a packet involved in a collision will be retried. You may occasionally see duplicate copies of packets in this mode if the acknowledgment packet is lost.

If you have an odd number of stations participating in this sort of conversation, one station can be connected to itself via another station as a digipeater.

This station will have the disadvantage of seeing its own packets re-displayed. For example, suppose **W6YEY**, **W6WNE**, **W6UOU**, **KD6NWL**, and **K7FT** wish to carry on a group conversation.

To make all of the transmissions reliable as possible, the following connections are made:

**W6YEY connects to KD6NWL**  
**W6UOU connects to K7FT**  
**W6WNE connects to W6UOU via KD6NWL**

If each station specifies **MCON ON**, **MALL ON**, and **MONITOR ON**, each station will see the packets sent by all of the others.

✓ The **STREAMSW** command allows you to actually connect to more than one station at the same time.

Since this feature is confusing to inexperienced packet operators, we recommend that you wait until you know how to use the basic TNC commands before you attempt to use this command.

You can find more information about the **STREAMSW** command in the floppy disk comes with the AR-210. To access the command list in the diskette, refer to the "Commands and Messages" section of this Manual.

## USING THE BULLETIN BOARD (BBS) FEATURE

Unlike most packet radio TNC's that are currently available, your AR-210 has a bulletin board feature built in. This feature allows other stations to retrieve and store messages to and from them at any time in your system, which acts as a "mailbox".

Assume you want to send a message to a specific station that you know is on packet radio, but that station is not on the air when you are. A bulletin board enables you to leave a message for that station with a bulletin-board-equipped station that is always on the air.

Now, when the station you left the message for comes on the air, he can contact the third station and read your message. If he wishes, he can then leave a message for you to retrieve when you return to the air.

The special commands that pertain to bulletin board operation are shown in Table 3-1.

To set up your station as a BBS, perform the following steps:

1. From the Command Mode, type "MB ON" followed by a <RETURN> to turn the BBS on.

```
cmd: MB ON <RETURN>
MBOD was OFF
```

2. Set MYMCALL to your call sign, if this has not already been done.

- ✓ Many stations use an SSID after their call sign to distinguish the BBS from their main station. If you enter the same call sign, the TNC will respond you with :

```
Call duplicate I
```

Enter the call sign with SSID such as :

```
cmd: MYM W6YEV-1 <RETURN>
MYMCALL was
```

3. Set DAYTIME, if this has not already been done.

- ✓ If you do not set DAYTIME, message will not be time and date stamped.

```
cmd: DA YYMMDDHHmmSS
```

Example: cmd: DA 921030091530

(Year=92, Month=October, Date=30, Hours=09, Minutes=15 and seconds=30 )

If W6WNE now connects to your BBS, for example, he will see the following message while your TNC waits for a command:

```
WELCOME TO W6YEV-1'S MESSAGE BOARD
AR-210 message board Ver 1.28E
CMD (F/K/M/R/W/B/H/?)
```

- ✓ The letter in parentheses correspond to the mnemonics of the commands listed in Table 3-1.

If your computer or terminal is turned on, it will display:

```
K:*** CONNECTED W6WNE
```



**Table 3-1**

**Message Board Command List**

Command	Abriivation	Parameter	Default	Purpose
3RDPARTY	3RD	ON/OFF	ON	Inhibit 3rd party access to the BBS.
DAYTIME	DA	YYMMDDHHmmss	Blank	Time and date stamps messages stored on the BBS.
MAIL	MAI	ON/OFF	OFF	Turn incoming mail indicator ON/OFF.
MTEXT	MT	Text	None	BBS connect message.
MYMCALL	MYM	CALL (-n)	Blank	Your BBS call sign.
MBOD	MB	ON/OFF	OFF	Turn BBS on and off.
BYE	B	None	None	Terminates BBS operation.
FILE	FI	None	None	Prints a BBS file on your terminal or computer.
HELP	H	None	None	Displays a help message.
KILL	KI	"n"	None	Deletes nth message from the BBS. NOTE: You can kill only those messages that were sent to or from yourself.
		% or &	None	Deletes the 10 oldest messages from the BBS.
READ	R	"n"	None	Reads the nth message from the BBS.
ROUTE	ROU	ON/OFF	ON	Include or exclude a routing information (route header) during FWD operation.
WRITE	W	Call sign	None	Write a message in the BBS with attention to call sign. If you do not specify a call sign, the BBS writes the message to ALL.
?	?	None	None	Same as HELP.

**(SOP (System Operator) can also use any of these commands, except BYE and from the command mode.**

## 4. COMMANDS AND MESSAGES

### COMMAND LIST & COMMAND SYNTAX

The terminal node controller (TNC) uses many variable **parameters**, such as your call sign, terminal type, display preferences, and the characteristics of your radio in its operation.

In addition, you can command the TNC to perform several **tasks**, such as connecting to another station to start a conversation, disconnecting at the end of the QSO, or displaying information about itself.

You can change parameters and issue instructions to the TNC by typing **commands** comprised of word abbreviation called key-words, or by typing **variables** that consist of numbers or strings of characters you select.

You will probably never change some of these parameters. The TNC is designed to provide you with maximum flexibility so you can adapt it to your particular environment.

The enclosed diskette contains all the commands which are listed alphabetically. You can print-out those commands by typing from the A: prompt on the computer, like

```
A: TYPE MANUAL.DOC > PRN [Enter].
```

You may also edit this ASCII file through your favorite word-processor or screen editor.

If a command has parameters, each parameter is described and the default value is given. The defaults are the EPROM's stored values, which you may load by typing the RESET command. Each parameter is described and the possible values are given.

Refer to the " OPERATION " section for a more detailed discussion of many of the commands and their interrelationships. Enter the command in the TNC by typing it when you see the command-mode prompt:

```
cmd:
```

The command key-words and parameters are separated by spaces, and the TNC takes action after you press the RETURN key.

You may enter key-words in upper- or lower-case.

You may abbreviate all commands and alphabetic parameters to the shortest unique sign. These minimum abbreviations are shown to the left of each command's full name.

There are several types of parameters. A parameter denoted as 'n' is a number, and can be given either in decimal or in hexa-decimal (base 16). When the TNC shows some of these parameters (those which set special characters), they are given in hexa-decimal.

A hexa-decimal number is distinguished from a decimal number by the "\$" prefix that precedes it.

The "digits" of a hexa-decimal number represents powers of 16, analogous to the powers of 10 represented by a decimal number.

The number 10 through 15 are denoted by the hexa-decimal digits A through F. For example :

$$\text{\$1B} = 1 \times 16 + 11 = 27$$

$$\text{\$120} = 1 \times 16 \times 16 + 2 \times 16 = 288$$

The **TRACE** command parameter is given as a bitcode. This means that several related values are simultaneously set by this command, and the parameter is formed by adding together the numbers that correspond to each desired value.

You may find it convenient to think of this number in hexa-decimal.

Many parameters are "flag", meaning that they have two possible values, **ON** and **OFF**, or **YES** and **NO**. All of the commands description show **ON** and **OFF**, or **YES** and **NO**.

All of the commands descriptions show **ON** and **OFF** as the options. You may type **YES** and **NO**.

A few parameters are really flags, but rather than indicating that something is "on" or "off", they select one of two ways of performing a task. Some of these parameters have the value **EVERY** or **AFTER**, indicating how a time interval for a repeated action is to be treated. Others are **CONVERS** or **TRANS**, indicating operating modes for data transmission.

Several commands require call signs as parameters. While these parameters are normally amateur radio call signs or station ID, they may actually be any collection of numbers and at least one letter (up to six characters).

Call signs or other similar designations (called aliases) are used to identify stations sending and receiving packets.

A call sign may additionally include an " extension ", a decimal number between 0 and 15 that is used to distinguish between two or more stations on the air with the same call sign ( such as a base station and repeater ).

You enter the call sign and extension, which are then displayed at call-ext; that is, **W6UCU-7**. If you do not enter the extension, it is set to -0. Extensions of -0 are not displayed by the TNC.

Several parameters are numerical codes for characters which perform special functions. The code is simply the ASCII character code for the desired character.

These characters have **control characters** as default values. You enter a control character by holding down a special **control** key on the keyboard while you press the indicated key.

There are two commands, **BTEXT** and **ID**, which have a text string as parameters. These strings can be any combination of letters, numbers, punctuations, or spaces up to 239 characters. You can even put characters with special meanings, such as **RETURNS**, into string by preceding them with the " pass " character. The string ends when you type a ( non-passed ) **RETURN**.

In the user command list in a supplied disk, the key-words are shown in uppercase. User-supplied values are shown in lower-case.

If you must choose a parameter from one or two values, the choices are separated by a vertical bar. Optional parameters are shown in square brackets. For example :

```
KEYWORDS var A/B [C/D]
```

This means that the command **KEYWORDS** requires a user supplied variable " var " and either A or B. In addition, you can optionally specify C or D.

You can examine the value of any parameter by typing the command which sets this parameter followed by a **RETURN**. A special command, **DISPLAY**, allows you to see the values of all parameters or groups of related parameters.

## 5. IN CASE OF DIFFICULTY

Your TNC was thoroughly checked at the factory to make sure it operates properly prior to shipment. In most case, any problem you experience with the unit will be external ( wiring, computer or terminal configuration, etc. ). The following " Troubleshooting Chart " should help you determine several common problems.

**Troubleshooting Chart**

PROBLEM	POSSIBLE CAUSE
PWR LED does not light when you turn the unit on.	1. External power supply not turned on. 2. External power supply not properly connected to the unit. 3. Optional internal battery needs to be charged.
Unit will not communicate with the terminal.	1. Improper cable connection between the unit and the terminal or computer. 2. Wrong configuration ( baud rate etc. )
Does not receive packets from other stations.	1. Improper connections between the unit and your radio. 2. Radio's volume control not set properly.
Cannot transmit packets.	1. MYCALL not set. 2. Improper connections between the unit and your radio. 3. Improper setting of control VR3 (refer to " Tests and Adjustment " section.

## APPENDIX

### LIST OF COMMANDS AND DEFAULTS

The following pages shows all commands available to the AR-210.

The **Class** column indicates that :

- AS** - Asynchronous Port Commands and Parameters
- IC** - Immediate Commands
- IP** - Identification Commands and Parameters
- LP** - Link Commands and Parameters
- MB** - Message Board Commands and Parameters
- MP** - Monitor Commands and Parameters
- SC** - Special characters
- TP** - Timing Parameters

## APPENDIX - LIST OF COMMANDS AND DEFAULTS

MINEMONIC	COMMAND	PARAMETER	DEFAULT	FUNCTIONS	CLASS	NOTE
8	8BITCONV	On / Off	On	The high order bit is not stripped in Converse Mode.	AS	M
MM	MACRO	1 - 4	Empty	Select macro channel. Up to 119 characters can be stored in the macro text.	IC	A
3RD	3RDPARTY	On / Off	On	Allows the 3rd party to access the BBS.	MB	A
A	AZ25LV2	On / Off	On	The TNC uses AX.25 Level 2 Version 2.0 protocol.	LP	A
AB	ABAUD	300 - 19200	1200	Specify data rate, in baud, on the serial I/O terminal port.	AS	A
AF	AFILTER	n1 - n4	\$0	Deletes specific characters as specified during connect state in the Converse mode.	LP	A
AU	AUTOLF	On / Off	On	A <LF> character is added to incoming packets following each <CR> transmitted.	AS	M
AW	AWLEN	7 / 8	7	7 or 8 specifies the number of data bits per word.	AS	M
AXD	AXDELAY	0 - 120	0	0-120 specifies a key-up delay for voice repeater operation in 10mS. intervals.	TP	
AXH	AXHANG	0 - 250	0	0-250 specifies the voice repeater hang time in 100 mS. intervals.	TP	
B	BEACON	E/A 0 - 250	Every 0	Specifies how the beacon packet is sent out from the TNC.	IP	
BBS	BBSMSG5	On / Off	Off	Selects how the beacon packet is sent out from the terminal.	AS	
BK	BKONDEL	On / Off	On	The sequence <BKSPC><SPC><BKSPC> is echoed when a character is deleted.	SC	M
BT	BTEXT	Text	Empty	Text string for beacon packet. Up to 256 characters can be used.	IP	M
BU	BUDLIST	On / Off	Off	Causes the TNC to ignore frames from stations that are in the LCALLS list.	MP	
C	CONNECT	-	-	Immediate command that initiates a connect request to other stations.	IC	A
CAL	CALIBRA	-	-	Initiate calibration tone. (Mark and Space tone at 50% duty cycle.)	IC	A
CAN	CANLINE	0 - \$7F	\$18	Changes the CANCEL-LINE input editing command character.	SC	
CANP	CANPAC	0 - \$7F	\$19	Changes the CANCEL-PACKET input editing command character.	SC	
CB	CBELL	On / Off	Off	BELLS are not sent with the CONNECTED message.	IP	
CH	CHECK	0 - 250	30	Set a time-out value for a packet connection.	TP	
CID	CIDCON	E/A 0 - 250	Every 0	Specify how the CW ID is sent out from the TNC.	TP	A
CIM	CMDTIME	0 - 250	1	Set time-out value in the Transparent Mode.	TP	
CMS	CMSG	On / Off	Off	Toggles the message in CTEXT when connection is established.	IP	
CMS3D	CMSGDISC	On / Off	Off	Toggles automatic disconnect after the TNC sends the CTEXT message.	IP	M
COM	COMMAND	0-\$7F	\$3	Changes the Command Mode entry character.	SC	
CONM	CONMODE	C / T	Converse	Selects the mode your TNC uses after entering the CONNECTED state.	LP	
CONO	CONOK	On / Off	On	Toggles connect request from other stations.	LP	
CONP	CONPERM	On / Off	Off	The current channel can be connected to and disconnected from other stations.	LP	
CONS	CONSTAMP	On / Off	Off	Toggles whether time stamp is included with connect status message.	MP	
CONV	CONVERSE	-	-	Changes command mode to converse mode.	IC	
CP	CPACTIME	On / Off	Off	Toggles packet transmit timer in the Converse Mode.	TP	
CR	CR	On / Off	On	Toggles whether the CR is included in the send-packet in the Converse Mode.	LP	
CS	CSSTATUS	-	-	Immediate command that displays the status during multiple connections.	IC	
CT	CTEXT	Text	Empty	Up to 239 characters can be stored as "automatic answer" text.	IP	M

## APPENDIX - LIST OF COMMANDS AND DEFAULTS

MNEMONIC	COMMAND	PARAMETER	DEFAULT	FUNCTIONS	Class	Note
CWID	CWID	Text	Empty	Text string for CW ID. Up to 16 characters can be stored.	IP	A
D	DISCONN			Immediate command that initiates a disconnect request to other station.	IC	A
DA	DAYTIME			Set current DATE and Time.	IC	M
DAYSTAMP	DAYSTAMP	On / Off	On	Use in conjunction with TIME command. Add date stamp in the time stamp.	MP	A
DAYU	DAYUSA	On / Off	On	Toggles date format between MM/DD/YYYY and DD/MM/YYYY.	MP	M
DEL	DELETE	On / Off	Off	Select the key to use for deleting while editing.	SC	
DIG	DIGPEAT	On / Off	On	Enable and disable the digipeater function.	LP	
DISCONE	DISCONE	On / Off	On	Add CTRL-Q (300) after disconnect message. ( * * * DISCONNECTED)	LP	A
DISP	DISPLAY			Display parameters to the terminal or computer.	IC	M
DT	DTEXT	Text	Empty	Up to 120 characters can be stored as "disconnect" text.	IP	A
DW	DWAIT	0 - 250	16	0 - 250 specifies an additional duration in the digipeater operation.	TP	
E	ECHO	On / Off	Off	Toggles local echoing by the TNC when it is in the Command or Converse Mode.	AS	
ES	ESCAPE	On / Off	Off	Selects <ESCAPE> output characters.	AS	
F	FLOW	On / Off	On	Toggles type in flow control.	AS	
FJ	FILE			Display the message list in the BBS.	IC	A
FL	FLOWER	0 - 120	0	Specify duration on R5232C buffer to discard the data after buffer is full.	AS	
FR	FRACK	0 - 15	3	Specify frame acknowledgment time-out in 1 second intervals.	TP	
FU	FULLDUP	On / Off	Off	Enable and Disable the full duplex mode.	LP	
HB	HBAUD	300 - 19200	1200	Specify the rate or signalling speed in baud from the TNC to the radio.	LP	A
HE	HEADERLN	On / Off	Off	The header and packet text of monitored packets are printed on the same line.	MP	
HEAL	HEALLED	On / Off	Off	Allows you to make a quick check of the TNC.	IC	
HI	HID	On / Off	Off	Enable and disable HDLC automatic periodic ID packet during digipeater.	IP	
I	ID			Immediate command that sends a special ID packet.	IC	
K	K			Same as CONVERSE. Change command mode to converse mode.	IC	
KI	KILL	On / Off	On	Erase or specify the method of erasing the messages in BBS.	MB	A
KISS	KISS	On / Off	Off	Enable and disable to support TCP/IP (KA9Q Inter-Net program).	LP	M
L	LCKOK	On / Off	On	If this command is set to off, the TNC translates lower-case characters to upper-case.	AS	
LCA	LCALLS	Call sign	Empty	Determine how the TNC monitors the packet channels and displays information.	MP	
LCS	LCSTREAM	On / Off	On	Enable and disable character case conversion after STREAMSWITCH.	SC	
LF	LFADD	On / Off	Off	Enable and disable to add the line feed characters in outgoing packets.	LP	
LFI	LFIGNORE	On / Off	Off	Causes the TNC to print any line feed characters it receives from other station.	LP	
LI	LIST			Immediate command that displays a list of message in the BBS.	IC	A
LOG	LOG			Immediate command that displays a list of stations that connected to the BBS.	IC	A
M	MONITOR	On / Off	On	Packet activity is monitored when the parameter is On.	MP	
MA	MALL	On / Off	On	Determines the class of monitored packets.	MP	

## APPENDIX - LIST OF COMMANDS AND DEFAULTS

MEMORIC	COMMAND	PARAMETER	DEFAULT	FUNCTIONS	Class	Note
MAI	MAIL	On / Off	Off	Enable and disable the incoming mail indicator.	MB	A
MAX	MAXFRAME	1 - 7	4	1 to 7 signifies a number of packet frames.	LP	
MB	MAXFRAME	On / Off	Off	Toggles message (bulletin) board On and Off	MB	A
MC	MBOD	On / Off	Off	Monitors only packets from the station you are connected to, if the default is off.	MP	
MCOM	MCOM	On / Off	Off	Only information frames are monitored, when the parameter is set to off.	MP	
MF	MFILTER	n1 - n4	\$0	Select characters to be "filtered", or excluded from monitor packets.	MP	M
MH	MHEARD	-	-	Immediate command that displays a list of stations heard.	IC	
MI	MINE	-	-	Immediate command that displays a list of received and sent messages in BBS.	MB	A
MMUI	MMUI	On / Off	Off	Monitors only UI-frame packets from the stations in the MTCALL list.	MP	A
MN	MNET	On/Off	Off	Ignores all back-bone NET/ROM packets when the parameter is set to off.	MP	A
MR	MREP	On / Off	On	Shows digitaters in the header when the parameter is set to on.	MP	A
MRC	MRCALL	Call sign (-n)	Empty	This command is used in conjunction with the MTCALL command.	MP	A
MS	MSTAMP	On / Off	Off	When the parameter is set to off, monitored frames are not time stamped.	MP	A
MT	MTEXT	Text	Empty	Special monitor functions during BBS operation.	MB	A
MTC	MTCALL	Call sign (-n)	Empty	Special monitor functions during BBS operation.	MP	A
MTR	MTR	On / Off	Off	If active, monitors only two stations specified by MTCALL and stations in MRCALL.	IP	M
MY	MYCALL	Call sign (-n)	Empty	Your call sign and an optional substation ID (SSID).	IP	M
MYA	MYALIAS	Call sign (-n)	Empty	Alternate identity of your TNC.	IP	M
MYM	MYMCALL	Call sign (-n)	Empty	Your call sign and an optional substation ID (SSID).	IP	M
NE	NEWMODE	On / Off	Off	Exclusive call sign for your bulletin board.	IP	A
NU	NUCR	On / Off	Off	Determines how your TNC behaves when the link is broken.	LP	
NUL	NULF	On / Off	Off	The TNC changes modes according to NEWMODE.	AS	
NULL	NULL	0 - 30	0	If parameter is on, <NULL> characters are sent to the terminal following <CR>.	AS	
P	PACLEN	0 - 255	128	If parameter is on, <NULL> characters are sent to the terminal following <LF>.	AS	
PACT	PACTIME	E/A 0 - 250	After 10	Specifies number of <NULL>-characters to be sent to the terminal after CR and LF.	LP	
PAR	PARITY	0 - 3	3	Set maximum number of user data bytes to be carried in each information field.	TP	
PAS	PASS	0 - \$FF	\$16	Used in the transparent mode. (Specify packet timeout.)	AS	
PASSA	PASSALL	On / Off	Off	0 to 3 selects a parity option for the terminal or computer.	AS	
PE	PPERSIST	0 - 250	127	Selects the ASCII character used for the "pass" input editing code.	LP	
PP	PERSIST	On/Off	On	If disabled (Off), the TNC will only accept packets with valid CRCs.	LP	
R	REDA	-	-	0-255 specifies the threshold value for a random-number attempt to transmit.	TP	A
RAMTEST	RAMTEST	-	-	TNC uses PERSIST and SLOTTIME when it executes p-persistent CSMA.	TP	A
RE	RETRY	0 - 15	10	Command for BBS. Read message.	IC	A
REC	RECONNECT	-	-	Immediate command to check the RAM. Set TNC to factory default value.	IC	A
				0 to 15 specifies the maximum number of packet retries.	LP	
				Allows you to change the path you are using to communicate with another station.	LP	



## APPENDIX - LIST OF COMMANDS AND DEFAULTS

MNEMONIC	COMMAND	PARAMETER	DEFAULT	FUNCTIONS	Class	New
RED	REDISPLA	0 - \$7F	\$12	Changes the redisplay-line input editing character.	SC	
REL	RELINK	On / Off	Off	Provided to prevent the disconnect during multiple connection.	LP	A
RES	RESPTIME	0 - 260	5	0-260 adds a minimum delay before the TNC sends acknowledgment packets.	TP	
RESET	RESET	-	-	Immediate command that resets all parameters to the TNC's EEPROM default set.	IC	M
RESTART	RESTART	-	-	Same as power. On / Off reset.	IC	M
ROU	ROUTE	On / Off	On	Include or exclude a routing information (route header) during FWD.	MB	A
RS	RSFLOW	On / Off	On	Enable and disable the hardware (DTR or CTS) flow control.	AS	A
RX	RXBLOCK	On / Off	Off	Add \$FF mark in front of all incoming packets.	AS	
S	SCREENLN	0 - 265	0	0 to 265 specifies a column width, in characters, of the terminal.	AS	
SE	SENDPAC	0 - \$7F	\$0D	Selects the character used to force a packet to be sent in the converse mode.	SC	
SL	SLOTTIME	0 - 250	10	Works in conjunction with PERSIST command to activate true P-persistent CSMA.	TP	A
SOFTDCD	SOFTDCD	On / Off	Off	Enable and disable software based DCD circuit.	LP	A
SQ	SQUELCH	On / Off	Off	Check channel activity by squelch line. (Option)	LP	A
STA	START	0 - \$7F	\$11	Choose the user start character. (Default is CTRL-Q)	SC	
STO	STOP	0 - \$7F	\$13	Choose the user stop character. (Default is CTRL-S)	SC	
STR	STREAMSW	0 - \$7F	\$01	Enable and disable the characters to show that a new connection channel is being addressed.	SC	M
STREAMC	STREAMCA	On / Off	Off	Displays the call sign of the "connected-to" station after the channel identifier.	SC	
STREAMD	STREAMDB	On / Off	Off	Displays received STREAMSW characters as doubled characters.	SC	
T	TRANS	-	-	Switches the TNC from the Command mode to Transparent mode.	IC	
TC	TCLEAR	-	-	Immediate command that clears the buffer.	IC	A
TI	TIME	0 - \$7F	\$14	Selects the time stamp trigger character.	SC	A
TOUT	TOUT	0 - 250	30	0-250 specifies the message board time-out.	TP	A
TRAC	TRACE	On / Off	Off	The TRACE command activates the AX.25 protocol display.	LP	
TRF	TRFLOW	On / Off	Off	Selects flow control in the transparent mode.	AS	
TRI	TRIES	0 - 15	0	Retrieves (or forces) the count of "tries" on the data channel presently selected.	LP	
TX	TXDELAY	0 - 120	50	Specifies the waiting period before sending packet frame data after keying.	TP	
TXF	TXFLOW	On / Off	Off	Enable and disable software flow control in the transparent mode.	LP	
TXU	TXUIPRAM	On / Off	On	Enable and disable the transmission of un-protocol packets.	AS	
U	UNPROTO	Call sign (VIA)	CQ	Set the digipeat and destination address fields of packets.	IP	
US	USERS	0 - 10	1	0 to 10 specifies the number of active simultaneous connections.	LP	
W	WRITE	Call sign	Empty	Write message into the message board (BBS.)	IC	A
X	XFLOW	On / Off	Off	Enable and disable the software flow control.	LP	
XM	XMITOK	On / Off	Off	Enable and disable the PTT line function to the transmitter.	AS	M
XO	XOFF	0 - \$7F	\$13	Selects the TNC stop character that is sent to the computer or terminal.	SC	
XON	XON	0 - \$7F	\$11	Selects the TNC start character that is sent to the computer or terminal.	SC	

## APPENDIX - LIST OF COMMANDS AND DEFAULTS

### CLASS :

- AS - Asynchronous Port Parameters.
- IC - Immediate Commands.
- IP - Identification Parameters.
- LP - Link Parameters.
- MB - Message Board Parameters.
- MP - Monitor Parameters.
- SC - Special Characters.
- TP - Timing Parameters.

### NOTE:

- \* "A" indicates the new commands for the AR-210. These commands are not included in the TAPR TNC-2 Release 1.1.6.
- \* "M" indicates the modified commands for the AR-210. The default value, parameters, and functions are slightly different than the TAPR TNC-2.

The AR-210 can display the contents of the following counters in much the same way as commands. You can type "DIPSP H" to see all of the counters, or you can type counter name or its mnemonic.

COUNTER	Mnemonic	COUNT CONDITION
ASYRXOVR	AS	The software does not communicate with the asynchronous receiver fast enough.
BBFAILED	BB	This counter stores the number of times the bBRAM checksum is in error.
DIGISENT	DIGS	The TNC digitize a frame.
HOWRERR	HO	The HDLC receiver does not obtain data fast enough, and results in lost data.
HUNDERR	HU	The HDLC transmitter does not obtain data fast enough, and frames are aborted.
RCVDFRMR	HU	The TNC receives frame rejected frames from a connected station.
RCVDIFRA	RCVDF	The TNC receives an I-frame from a connected station.
RCVDREJ	RCYDI	The TNC receives a reject frame from a connected station.
RCVDSABM	RCVDR	The TNC receives an SABM frame that is addressed to it.
RXCOUNT	RCVDS	The TNC receives a frame that has a good CRC.
RXERRORS	RXC	The TNC discards the bad frame.
SENTFRMR	RXE	The TNC transmits a frame reject frame.
SENTIFRA	SENTF	The TNC sends an I-frame.
SENTREJ	SENTI	The TNC transmits a Reject frame.
TXOOVFLW	SENTR	The TNC correctly transmits a frame.
TXTIMO	TXC	The frame is discarded when the outgoing frame queue is too small.
	TXQ	This counter stores the number of times the HDLC transmitter is time-out.
	TXT	

## **SERVICE INFORMATION**

The TNC-210 is fully tested before shipment. If for any reason that service is required, please contact your dealer where the unit was purchased from. If you have difficulty in obtaining service from your local dealer, please contact one of the following address.

Please include full explanation of the trouble or symptoms together with the detail of associated equipment, including the type of radio and terminal or computer.

In United States, Mexico and Canada

HENRY RADIO, Inc.  
2050 South Bundy Drive  
Los Angeles, CA 90025 U.S.A.

Telephone : 310-820-1234  
Facsimile : 310-826-7790

Attention : Customer Service Department

For outside of the above area

AOR, Ltd.  
2-6-4 Misuji, Taito-Ku, Tokyo 110 Japan

Telephone : 81-3-3865-1681  
Facsimile : 81-3-3865-1697

Attention : Customer Service Department

**AOR AR210 TNC ADDENDUM TO THE OPERATING MANUAL**

connections for IBM

replace the two tables shown on page 1-2 with the following  
information.

Table 1-2 IBM PS2, AT 9 pin connector

AR210	9 WAY IBM COMPUTER RS232
2	2
3	3
5	5
7	7
8	8

Table 1-3 IBM PC/XT 25 pin connector

AR210	25 WAY IBM COMPUTER RS232
2	3
3	2
5	7
7	4
8	5

# SPECIFICATION SHEET

## AOR MODEL AR-210

Processor	Z80A, soft-compatible ASIC TMPZ84C015BF-6
Memory Backup	Lithium battery.
Serial Port Baud rates:	RS-232C interface to terminal or computer. 300, 600, 1200, 2400, 4800, 9600 and 19200 Auto Baud routine is available. The default, or reset, baud rate is 1200.
Commands	TAPR TNC-2 up-load compatible.
Modem Port	1200 baud FSK
Protocol	AX.25 Level2, Version 1.1.4TE
Power Requirements	External 10 to 13.8 VDC at 200mA. (55mA from internal 4.8 volt, 120mAH Nicad battery. )
Input Level	20mV to 2V peak to peak, 18 $\Omega$ .
Output Level	0 to 300mV (variable).
Push-to-talk	30V maximum at 100mA
Overall Dimensions	2-1/2" W x 1"H x 1-1/4" L
Net Weight	3.3 oz.

*Manufacturer reserves the right to discontinue products and changes specifications at any time without incurring any obligation to incorporate new features in products previously sold.*

## AOR AR-210 Technical Highlights

- ❑ Extremely compact & light weight - 2-1/2" x 1" x 4-1/4" 3.3 oz.
- ❑ High reliability multi-layer PC board to suppress interferences.
- ❑ Built with latest SMT. Highly improved reliability by SMDs.
- ❑ Built-in Nicad battery operation. (Option) and quick charging circuit.
- ❑ Low power consumption. Ideal for battery operation with HT.
- ❑ Improved CPU speed. (4.9152 MHz)
- ❑ Compatible with most standard TNCs. AFSK 1200 baud.
- ❑ TAPR TNC-2 upper compatible.
- ❑ Convenient hand-held transceiver jacks.
- ❑ High performance MODEM LSI / TCM3105NL
- ❑ Built-in real-time clock backed up by lithium cell.
- ❑ Support TCP/IP KISS mode.
- ❑ Multitasking BBS. - While connecting MYCALL
- ❑ Many new commands and enhanced monitor function.
- ❑ RS-232C port supports up to 19,200 baud.
- ❑ Externally accessible hard reset switch.
- ❑ Industry standard DE-9 computer connector.
- ❑ NEW COMMANDS NOT COVERED BY ORIGINAL TNC-2.

MACOR	LOG	RETRY
3RDPARTY	MAIL	RELINK
ABAUD	MCON	ROUTE
AFILTER	MINE	RSFLOW
CALIBRA	MMUI	SLOTTIME
CIDCON	MNET	SOFTDCD
CWID	MRCALL	TCLEAR
DAYSTAMP	MTEXT	TIME
DISCONE	MTR	TOUT
DTEXT	MTCALL	WRITE
FILE	PPERSIST	
KILL	READ	
LIST	RAMTEST	

## **ABOUT BAUD AND BPS.**

Modern commercial and amateur terminology no longer always refer to the speed or data rates in "WPM". The term "baud" is now accepted for FSK and AFSK operations using mono-bit data. In these cases, the terms "baud" and "bits-per-second" mean the same thing. Either term may be used.

*Heath Kit HK-21 Manual Page 4-26*

The terminology of bits-per-second and baud-rate have different meanings.

In general, bit-per-second (BPS) is a value for "number of information can be transferred within one (1) second.

In contrast, the baud-rate is a value for "number of symbols on the base band signal can be transferred within one (1) second. Thus the baud rate is:

Baud Rate = Number of symbols / Second

In standard two symbolic modulation, i.e. ASK, AFSK, MSK, (information 1 and 0) express the same result. Baud Rate = BPS.

In 4 symbolic modulation, for example, the Baud Rate = BPS/2 or BPS = 2 X Baud Rate.

Such modulations includes, M-ary ASK, M-ary PSK, QAM etc. with multiple symbolic modulation. (information 1, 2, 3, 4 etc.)

*Packet Network Handbook Page 37-43 (CQ Publishing - Tokyo)*



Authority On Radio communications

**AOR, LTD.**

2-6-4 MISUJI  
TAITO-KU, TOKYO 111, JAPAN  
Telex: J29188 AORCOM  
Fax: 03-3865-1687 / 03-3862-9927  
Phone: 03-3865-1681

NEWS RELEASE

NOVEMBER 15 1992

TOKYO - JAPAN

AOR, LTD. has announced the model AR-210, a worlds smallest TNC (terminal node controller) for packet radio.

The AR-210 weight only 3.3 ounce and measured 2-1/2 x 1 x 4-1/4 inches.

All major components are SMD and built with latest SMT (Surface Mount Technology) to improve reliability and durability for long-term use.

The unit can be operated either external DC 12 volts or internal Nicad battery for portable and field installation.

The AR-210 is compatible with an industry standard FSK 1200 BPS. packet radio using proven error free AX.25 protocol.

The application includes "point to point data transfer", "remote data gathering", "weather telemetering", "local radio bulletin board service", "amateur radio" and "remote control"

AOR, LTD.  
2-6-4 Misuji  
Taito-ku, Tokyo 111  
J a p a n





## AOR AR210 ~ Packet Radio TNC

*Portable packet TNC ~ Size and cost to suit your pocket!*

The AR210 must be one of the smallest (if not the smallest) self-contained TNC on the market place today. Size is extremely small measuring only 100 x 60 x 22mm approx, the TNC is also ultra-light weight being a mere 90g (without optional NiCad battery pack fitted).

All major components are SMD and built with the latest SMT (Surface Mount Technology) to improve reliability and durability for long-term use, this also enables the very compact case size. The AR210 uses internationally adopted AX.25L2V2 1200 baud AFSK packet.



- \* Extremely compact
- \* High reliability multi-layer PCB
- \* SMD built using SMT 'no wires'
- \* Optional internal NiCad battery!
- \* RS232C support from 300 ~ 19200 baud plus ABAUD
- \* Standard female DE9 RS232C connector
- \* Lithium backed internal BBS with mail indicator and real time clock
- \* CWID & 3rd party commands
- \* Two sets of connection leads plus DC lead
- \* Ideal for portable or shack use

The AR210 may be operated either from an external DC supply of 10 - 13.8V or from an optional internally fitted 120 mAh rechargeable NiCad battery pack drawing just 4.8V @ 55 mA. The internal battery pack may be charged from an external DC supply if rated at a nominal 12V DC @ 200 mA or more. This makes the AR210 ideal for use both in the shack and when out portable or mobile.

Despite the small size, nothing has been compromised. The AR210 features five status LED indicators (CON STA PTT DCD PWR), a flashing STA indicator is also used to show mail waiting. There is also a power On/Off switch mounted on the front panel. Connection to a transceiver may be by either of the two methods provided. Firstly a multi-pin connector and secondly via a pair of 3.5/2.5mm jack plugs which are ideal for hand-portable use.

The rear case has a standard 9 pin female DE9 RS232C socket for connection to a terminal or computer. Power input is via a 2.1mm standard dual concentric socket (centre negative). An externally accessible hard reset switch is also provided on the rear case.

The AR210 is based on \*TAPR TNC-2 Upper compatible firmware version 1.14TE with an extended command set, this is however of Japanese development and the number does not directly relate to the U.S.A. numbering system. The heart of the TNC features a Z80A compatible ASIC TMP284C015BF-6 CPU running at 4.9152 MHz allowing RS232C baud rates of 300, 600, 1200, 4800, 9600 & 19200. The default is 1200 baud, AUTO-BAUD is also available. A high performance LSI/TCMS105NL modem chip is used. *N.B. The AR210 is not suitable for the fitting of \*NETROM or \*TheNet chips etc.*

The AR210 is supplied with two sets of leads for interconnection to a transceiver, DC power lead, English language operating manual detailing connection and use plus \*IBM-PC compatible disk 3.5 inch 720k format (5.25 inch 360k available to request).

The extended command list includes: Lithium backed internal BBS with real-time clock, 3rd party & CWID for compliance with the UK licence requirements, mail indicator, KISS, Diagnostics, Calibration, Special monitor and much more...

*AR210 Front view (Illustration larger than real life!)*

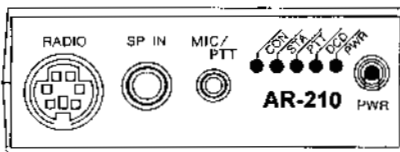

*AR210 Rear view (Illustration larger than real life!)*

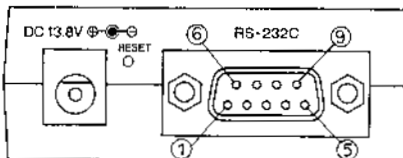

## AR210 - List of available commands:

RBITCONV OFF	AX25L2V2 ON	ABAUD 9600	AFILTER \$00	ASYRXOVR 0	AUTOLF ON
AWLEN 8	AXDELAY 0	AXHANG 0	BEACON	EVERY 0	BBFAILED 0
BBSMSG ON	BKONDEL ON	BTEXT	BUDLIST OFF	CBELL OFF	CONPERM OFF
CHECK 30	CIDCON EVERY 0	CMDTIME 1	CMSC OFF	CMSSGDISC OFF	CPACTIVE OFF
CR ON	CTEXT	CANLINE \$18	COMMAND \$03	CANPAC \$19	CONOK ON
CONMODE CONVERSE		CONSTAMP OFF	CWID	DISCONE ON	DAYSTAMP ON
DAYUSA OFF	DELETE OFF	DWAIT 16	DIGIPEAT ON	DIGISENT 0	DTEXT
ECHO OFF	ESCAPE OFF	FLOW OFF	FLOVER 0	FRACK 3	FULLDUP OFF
HEADERLN OFF	HEALLED OFF	HID ON	HOVRERR 0	HUNDRERR 0	KISS OFF
KILL ON	LCKOK ON	LFADD OFF	LFIGNORE OFF	LCALLS	LCSTREAM ON
MONITOR OFF	MBODON	MAIL ON	MALL ON	MCONOFF	MFILTER \$00
MRPT ON	MSTAMP OFF	MRCALL	MTCALL	MTEXT	MTR OFF
MMUI OFF	MYCALL	MYALIAS	MYMCALL	MAXFRAME 1	MCOM OFF
MNET OFF	NEWMODE ON	NOMODE OFF	NUCR OFF	NULF OFF	NULLS 0
PACLEN 80	PARITY 3	PASS \$16	PASSALL OFF	PASSTIME AFTER 10	PERSIST 127
PPERSIST ON	RCVDFRMR 0	RCVDIFRA 0	RCVDREJ 0	RCVDSABM 0	RETRY 10
REDISPLA \$12	RELINK OFF	RESPTIME 5	ROUTE ON	RSPFLOW ON	RXBLOCK OFF
RXCOUNT 25	RXFERRORS 5	SCREENLN 0	SENDPAC \$00	SENTFRMR 0	SENTIFRA 0
SENTREJ 0	SLOTTIME 10	SOFTDCD OFF	SQUELCH OFF	START \$11	STOP \$13
STREAMSW \$7C	STREAMCA OFF	STREAMDB OFF	TIME \$14	TOUT 30	TRFLOW OFF
TRJES 0	TRACE OFF	TXCOUNT 0	TXDELAY 60	TXFLOW ON	TXQOVFLW 0
TXTMO 0	TXUIFRAM ON	UNPROTO CQ	USERS1	XFLOW OFF	XMITOK ON
XOFF \$13	XON \$11	3RDPARTY ON			

### Specifications:

Model: AR210  
Processor: Z80A soft compatible Application Specific Integrated Circuit.  
TMPZ84C015BF-6  
Memory backup: Lithium battery  
Serial port: RS232C 9 pin female connector DE9  
Serial port baud rate: 300, 600, 1200, 2400, 4800, 9600, 19200. The default is 1200 baud,  
ABAUD also possible  
Commands: TAPR TNC-2 up-load compatible  
Modem port: 1200 baud AFSK  
Protocol: AX.25 Level 2 Version 2. Firmware AOR V1.14TE  
Power requirements: External 10 to 13.8V DC @ 200mA.  
Internal 4.8V @ 55mA from rechargeable 120mAH NiCad battery pack  
Input level: 20mV to 2V peak-to-peak, 18 OHM  
Output level: 0 to 300mV (variable)  
Push-to-talk: 30V maximum @ 100mA  
Overall dimensions: 100 x 60 x 22 mm (approx)  
Net weight: 90g without internal NiCad pack fitted  
Supplied: AR210 TNC, 2.5-2.5mm lead, 3.5-3.5mm lead, multi-pin plug & lead, DC lead,  
Operating manual, \*IBM disk  
Optional: BP210 120mAH 4.8V NiCad battery for internal fitting

**\*\* Specifications subject to change without notice due to continuous development of the product. E&OE.**

\* All trade marks acknowledged.

*For more general information regarding 'packet radio' request our simple introductory leaflet.*

**AOR AOR (UK) Ltd.**

Adam Bede High Tech Centre,  
Derby Road, Wirksworth, Derby.  
DE4 4BG, England.  
Tel: 01629-825926  
Fax: 01629-825927





## **AOR Ltd**

2-6-4 Misuji, Taito-ku, Tokyo 111-0055, Japan.

Tel: +81 3 3865 1695 Fax: +81 3 3865 1697

post@ajorja.com www.ajorja.com

### **AOR (UK) Ltd**

4E East Mill, Bridgefoot, Belper, Derbys DE56 2UA, England

Tel: +44 1773 880788 Fax: +44 1773 880780

info@ajoruk.com www.ajoruk.com

### **AOR USA, INC.**

20655 S. Western Avenue, Suite # 112

Torrance, CA. 90501, USA

Tel: (310) 787 8615 Fax: (310) 787 8619

info@ajorusa.com www.ajorusa.com